



We appreciate your interest in our **Access Tile Tactile Detectable Warning Tile Systems**, and as requested we are enclosing our recently updated submittal package.

This informative compilation includes a copy of our brochure, product specifications, installation manuals, detail drawings, laboratory test results, cleaning and maintenance instructions, a sample warranty form, a letter of compliance, and our standard colors. This information should prove useful in determining the **Access Tile System** (Cast In Place Replaceable or Surface Applied) that is best suited to your project requirements. However, if additional information is required, such as project specific detail drawings and specifications, we would be pleased to produce a detailed proposal specific to your project requirements.

The principal features and benefits of **Access Tile System** represent the latest design innovations for detectable warning tiles. The primary features and benefits of Access Tile Tactile Systems are:

- Replaceable Open Ended Design - **Better Installations and Easy to Maintain**
- State of the Art Engineered Composite Technology – **Superior Performance**
- Consistent 2.35” Dome Spacing when Tiles are Adjoined – **ADA Compliant**
- Tamper Proof Stainless Steel Fastener Design with Nylon Anchors – **Corrosion Resistant**
- Diamond Grip™ Micro Prism Design – **Enhanced Anti-Slip Surface for Safety**
- Preassembled Tek Anchor System – **Lower Labor Costs**
- Largest selection of Standard Sizes and Colors – **Meets Any Project Requirement**
- QC Approved and ASTM Tested - **Highest Material Standards**
- Unprecedented **5 Year Standard Warranty** – **Install With Confidence**

The following overview of **Access Tile Tactile Systems**, together with the information contained in our submittal package will confirm the **Access Tile System** is best suited to meet your project requirements. If you would like to speak directly with our sales or engineering representatives please call us directly by dialing toll free **(888) 679-4022**.

Yours truly,

John Heffner
Vice President
Access Products Inc.
johnh@accessproducts.com



Product Presentation

Access Tile Tactile Systems is a market leader in detectable warnings and tactile systems for the visually impaired. Access Tile Tactile Systems are fully compliant with the Americans with Disabilities Act (ADA).

Applications

Access Tile Tactile Systems can be used anywhere the safety of the visually impaired is a concern such as curb ramps, depressed curb walkway systems, shopping malls and parking areas.

Features

Access Tile Tactile Systems are available in a variety of sizes and colors to suit your project specific requirements and a Replaceable Cast in Place design for new construction installations or a Surface Applied design for retrofit applications.

Benefits

- The Diamond Grip™ Micro Prism Surface provides an enhanced anti-slip surface.
- The open-end Easy Cast™ ribbed chevron underside channels air out from under the tile and enables a wet set installation in a matter of minutes.
- The tamper resistant fasteners allow for easy access to remove for a life cycle maintenance strategy.
- The Engineered Composite Technology provides excellent Cost/Value.
- The 2.35" Dome Spacing is ADA Compliant.

For Additional Information

Please visit the Access Tile Tactile Systems website at www.accesstile.com

Contact

Access Products Inc
241 Main St., Suite 100
Buffalo, New York 14203
(888) 679-4022

SURFACE APPLIED DETECTABLE/TACTILE WARNING SURFACES

SECTION 32 17 26

SURFACE APPLIED DETECTABLE/TACTILE WARNING SURFACES

PART 1 GENERAL

1.01 RELATED DOCUMENTS

A. Drawings and general provisions of Contract, including General and Special Conditions and Division 1 Specifications Section, apply to this Section.

1.02 DESCRIPTION

A. This Section specifies furnishing and installing Surface Applied Detectable/Tactile Warning Tiles where indicated. Not recommended for asphalt applications.

1.03 SUBMITTALS

A. Product Data: Submit manufacturer's literature describing products, installation procedures and routine maintenance.

B. Samples for Verification Purposes: Submit two (2) tile samples minimum 12"x12" of the kind proposed for use.

C. Shop drawings are required for products specified showing fabrication details, composite structural system, tile surface profile, fastener locations, sound on cane contact amplification feature, plans of tile placement including joints, and material to be used as well as outlining installation materials and procedure.

D. Material Test Reports: Submit complete test reports from qualified accredited independent testing laboratory's to qualify that materials proposed for use are in compliance with requirements and meet or exceed the properties indicated on the specifications. All tests shall be conducted on a Surface Applied Detectable/Tactile Warning Tile system as certified by a qualified independent testing laboratory and be current within a 60 month period.

E. Maintenance Instructions: Submit copies of manufacturer's specified installation and maintenance practices for each type of Detectable Warning Tile and accessory as required.

1.04 QUALITY ASSURANCE

A. Provide Surface Applied Detectable/Tactile Warning Tiles and accessories as produced by a single manufacturer with a minimum of three (3) years experience in the manufacturing of Surface Applied Detectable/Tactile Warning Tiles.

B. Installer's Qualifications: Engage an experienced Installer certified in writing by Surface Applied Detectable/Tactile Warning Tile manufacturer as qualified for installation, who has successfully completed installations similar in material, design, and extent to that indicated for Project.

C. Americans with Disabilities Act (ADA): Provide Surface Applied Detectable/Tactile Warning Tiles which comply with the detectable warnings on walking surfaces section of the Americans with Disabilities Act (Title III Regulations, 28 CFR Part 36 ADA STANDARDS FOR ACCESSIBLE DESIGN, Appendix A, Section 4.29.2 DETECTABLE WARNINGS ON WALKING SURFACES).

D. California Code of Regulations (CCR): Provide only approved DSAAC detectable warning products as provided in the California Code of Regulations (CCR) Title 24, Part 2, Section 205 definition of "Detectable Warning". Section 1117A.4 and 1127B.5 for "Curb Ramps" and Section 1133B.8.5 for "Detectable Warnings at Hazardous Vehicular Areas".

E. Engineered Polymer Composite Surface Applied Detectable/Tactile Warning Tiles shall be manufactured from an ultra violet stabilized polymer composition with fiberglass reinforcement, the tile shall incorporate an in-line pattern of truncated domes measuring nominal 0.2" height, 0.90" base diameter, and 0.45" top diameter, spaced center-to-center 2.35" as measured side by side. For wheelchair safety the field area shall consist of a high density, diamond grip™ pyramid micro texture of raised points 0.05" high; "Access Tile" as manufactured by Access Products, Inc., Tel: 888-679-4022, or approved equal.

1. Dimensions: Surface Applied Detectable/Tactile Warning Tiles shall be held within the following dimensions and tolerances:

Specifiers Note: Edit section below by selecting desired length and width. Delete non-relevant dimensions.

Length and Width: [12x12] [24x36] [24x48] [24x60] [36x48] [36x60] [15' Radius Curve] {+/- .5"}

2. Compressive Strength of Tile when tested by ASTM D 695-08 not to be less than 25,000 PSI.

3. Tensile Strength of Tile when tested by ASTM D 638-08 not to be less than 12,500 PSI.

4. Flexural Strength of Tile when tested by ASTM D 790-07 Procedure A, not to be less than 30,000 PSI.

1.05 DELIVERY, STORAGE AND HANDLING

A. Surface Applied Detectable/Tactile Warning Tiles shall be suitably packaged or crated to prevent damage in shipment or handling. Finished surfaces shall be protected by sturdy wrappings and tile type shall be identified by part number.

B. Surface Applied Detectable/Tactile Warning Tiles shall be delivered to location at building site for storage prior to installation.

1.06 SITE CONDITIONS

A. Environmental Conditions and Protection: Maintain minimum temperature of 40°F in spaces to receive Surface Applied Detectable/Tactile Warning Tiles for at least 24 hours prior to installation, during installation, and for not less than 24 hours after installation.

B. The use of water for work, cleaning or dust control, etc. shall be contained and controlled and shall not be allowed to come into contact with the general public. Provide barricades or screens to protect the general public.

1.07 WARRANTY

A. Surface Applied Detectable/Tactile Warning Tiles shall be warranted in writing for a period of five (5) years from date of final completion. The guarantee includes defective work, breakage, deformation, fading and loosening of tiles.

PART 2 PRODUCTS

2.01 MANUFACTURERS

A. The Engineered Polymer Composite Surface Applied Detectable/Tactile Warning Tile specified is based on Access Tile manufactured by Access Products, Inc. (888-679-4022) existing engineered and

field tested products, which have been in successful service for a period of three (3) years are subject to compliance with requirements, may be incorporated in the work and shall meet or exceed the specified test criteria and characteristics.

B. Color: Yellow conforming to Federal Color No. 33538. Color shall be homogeneous throughout the tile. Tiles are also available in Dark Grey (Federal Color No. 36118), Onyx Black (Federal Color No. 17038), Brick Red (Federal Color No. 22144), and Colonial Red (Federal Color No. 20109).

2.02 MATERIALS

A. Fasteners: Color matched, corrosion resistant, flat head drive anchor: ¼" diameter x 1 ½" long as supplied by Access Products, Inc.

PART 3 EXECUTION

3.01 INSTALLATION

A. During all surface preparation and Surface Applied Detectable/Tactile Warning Tile installation procedures, ensure adequate safety guidelines are in place and that they are in accordance with the applicable industry and government standards.

B. The application of all tiles, adhesives, mechanical fasteners, and caulking shall be in strict accordance with the guidelines set by their respective manufacturers. Contact manufacturer for installation instructions relating to asphalt applications.

C. Coordinate with the Contractor or Engineer to ensure that the surfaces being prepared and fabricated to receive the tiles are constructed correctly and adequately for tile installation. Review manufacturer and contract drawings with the Contractor prior to the construction and refer any and all discrepancies to the Engineer.

D. Set the tile true and square to the curb ramp area as detailed in the design drawings, so that its location can be marked on the concrete surface. A thin permanent marker works well. Remove tile when done marking its location.

E. The surface to receive the Surface Applied Detectable/Tactile Warning Tile is to be mechanically cleaned with a diamond cup grinder or shot blaster to remove any dirt or foreign material. This cleaning and roughening of the concrete surface should include at least 4 inches around the perimeter of the area to receive the tile, and also along the cross pattern established by the corresponding areas on the backside of the tile. Those same areas should then be cleaned with a clean rag soaked in Acetone.

F. Immediately prior to installing the Surface Applied Detectable/Tactile Warning Tile, the concrete surfaces must be inspected to ensure that they are clean, dry, free of voids, curing compounds, projections, loose material, dust, oil, grease, sealers and determined to be structurally sound and cured for a minimum of 30 days.

G. Using Acetone, wipe the backside of the tile around the perimeter and along the internal cross pattern, to remove any dirt or dust particles from the area to receive the adhesive.

H. Apply adhesive to the back of the tile following the perimeter and internal cross pattern established by the tile manufacturer. Sufficient adhesive must be placed on the prescribed areas to have full coverage across the 2" width of the adhesive locator and shall be applied to within 1/4" continuously around the perimeter edge of the tile. The entire tube of adhesive shall be applied to the back of each tile, sizes 24" x 36" and greater.

I. Set the tile true and square to the curb ramp area as detailed in the design drawings.

J. Working from the center of the tile outwards, proceed to drill and install all fasteners in the tile's molded recesses.

K. Standing with both feet applying pressure around the molded recess provided in the tile, drill a hole true and straight to a depth of 3½" using a 1/4" masonry drill bit. Drill through the tile without hammer option (on the drill) until the tile has been successfully penetrated, then with hammer option (on the drill) to drill into the concrete. Maintaining foot pressure on both sides of the hole while drilling prevents concrete dust from accumulating between the tile and concrete which can affect the tile being installed flush and may compromise installation integrity.

L. Immediately after drilling each hole, before moving on to the next, and while still applying foot pressure, mechanically fasten tiles to the concrete substrate using a leather bound or hard plastic mallet to set the fasteners. Ensure the fastener has been placed to full depth in the dome, straight, and flush to the top of dome. Drive the pin of the fastener with the mallet, taking care to avoid any inadvertent blows to the truncated dome or tile surface.

M. Following the installation of the fasteners, the concrete dust should be vacuumed, brushed or blown away from the tile's surface and adjacent concrete. Using Acetone on a rag, wipe the concrete around the tile's perimeter to ensure a clean, dry surface to receive perimeter sealant.

N. Perimeter caulking sealant should be applied following the sealant manufacturer's recommendations. Tape all perimeter edges of the tile back 1/16" from the tile's perimeter edge and tape the adjacent concrete back 1/2" from the tile's perimeter edge to maintain a straight and even caulking line. Apply sealant around tile perimeter using care to work sealant into any void between the tile and concrete interface. Tool the perimeter caulking with a rounded plastic applicator or spatula to create a cove profile between the tile and adjacent concrete. Remove tape immediately after tooling perimeter caulking sealant.

O. Do not allow foot traffic on installed tiles until the perimeter caulking sealant has cured sufficiently to avoid tracking. Curing time is weather dependant (average cure time at 75° F is 30 minutes). Adhesive or caulking on the surface of the tile can be removed with Acetone.

P. If tiles are custom cut to size, if pre-molded recesses (to receive fasteners) are removed by the cut, or to maintain a tight installation to the substrate then any truncated dome can be center-drilled with a 1/4 inch masonry drill bit to create a through hole, and the through hole must be countersunk with a suitable carbide countersink bit to receive mechanical fasteners. Care should be taken to not countersink too widely or deeply. Fasteners should be flush with the top of the truncated dome when countersunk properly.

3.02 CLEANING, PROTECTING AND MAINTENANCE

A. Protect tiles against damage during construction period to comply with Tactile Tile manufacturer's specification.

B. Protect tiles against damage from rolling loads following installation by covering with plywood or hardwood.

C. Clean Tactile Tiles not more than four days prior to date scheduled for inspection intended to establish date of substantial completion in each area of project. Clean Tactile Tile by method specified by Tactile Tile manufacturer.

D. Comply with manufacturers maintenance manual for cleaning and maintaining tile surface and it is recommended to perform annual inspections for safety and tile integrity.

END OF SECTION

1'X1'

**SURFACE APPLIED
2.35" DOME SPACING**



Tactile Systems

www.AccessTile.com 888-679-4022

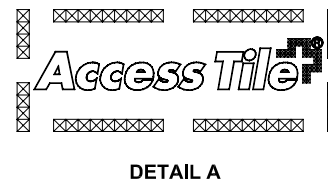
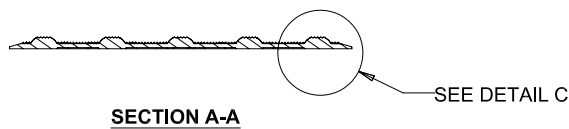
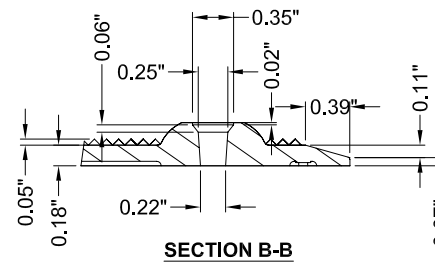
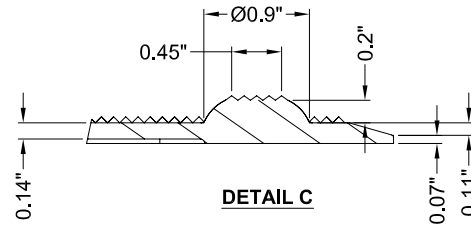
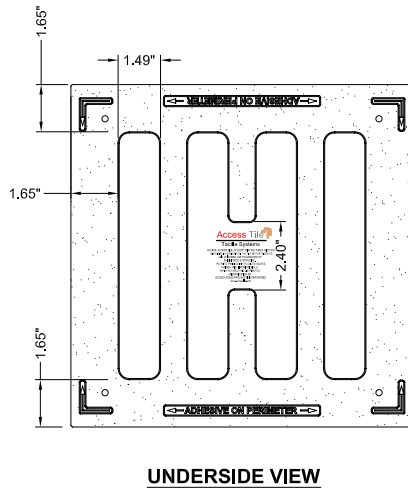
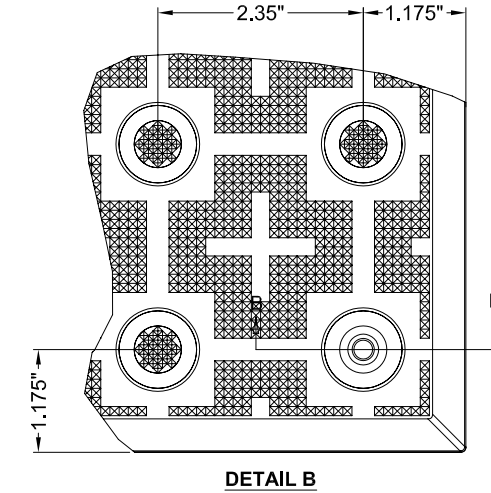
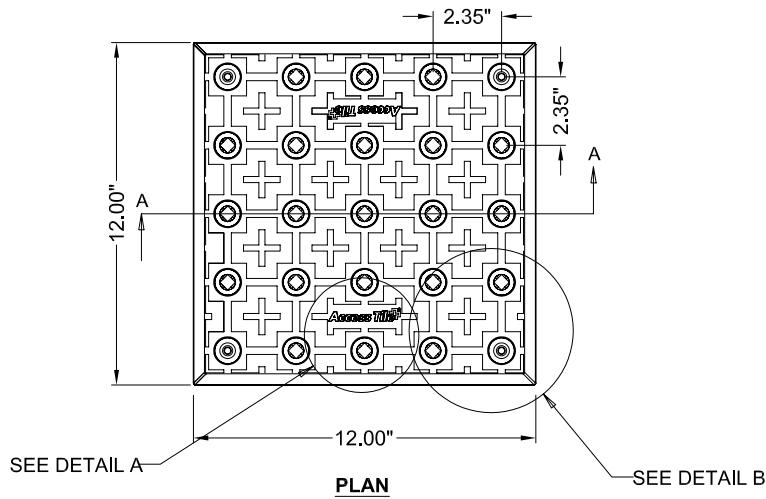

www.AccessTile.com

Access Products Inc

© Access Products Inc.
ACCESS, ACCESS TILE, ACCESS AND THE THREE AND TWO
DIMENSIONAL DESIGNS ON THE TILE BETWEEN DOMES
AND ON DOMES ARE TRADEMARKS OF
ENGINEERED SYSTEMS INC.
PATENTS PENDING IN THE UNITED STATES,
CANADA AND INTERNATIONALLY
MANUFACTURED AND DISTRIBUTED
UNDER LICENSE BY
ACCESS WORLD PRODUCTS INCORPORATED
www.accesstile.com
© KENNETH E.
SZEKELY

MATERIAL LIST

ITEM	DESCRIPTION	PART NO.	QTY
1	ACCESS TILE	ACC-S-1X1	1
2	Tek™ ANCHOR	ACC-S-ANCH	4
3	TACTILE BOND AND SEAL	TBS-010	1 ea

NOTE: FASTENERS ARE INCLUDED WITH TILE

REFERENCE DRAWINGS

DWG. NO.	DESCRIPTION

No.	DATE	REVISION	APPR.

SCALE
1"=1'-0" U.N.O.
FULL SIZE ONLY

DESIGNED	KES	DATE	10/09/2008
DRAWN	RWO	DATE	10/15/2008
CHECKED	KES		

PROJECT MANAGER

TRADE: DETECTABLE WARNING SURFACE PART NO. ACC-S-1X1

MATERIAL: POLYMER COMPOSITE

SUBJECT: **ACCESS TILE®**
TRUNCATED DOME, DETECTABLE
WARNING TACTILE SURFACE

PROJECT: **ACCESS TILE®**
TRUNCATED DOME, DETECTABLE
WARNING TACTILE SURFACE
1X1 SURFACE APPLIED
INLINE DOME TILE DRAWING.

DRAWING NO. ACC-S-1X1 REV. NO. Ø

2'X2'

**SURFACE APPLIED
2.35" DOME SPACING**



Tactile Systems

www.AccessTile.com 888-679-4022

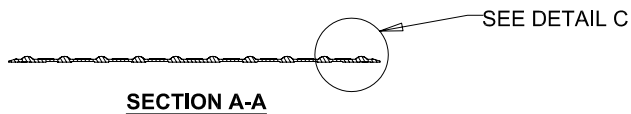
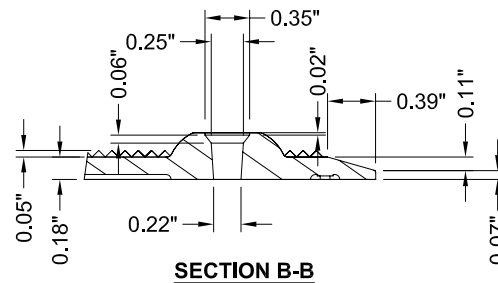
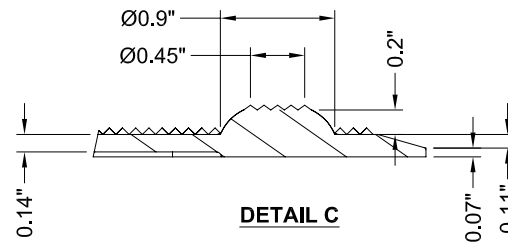
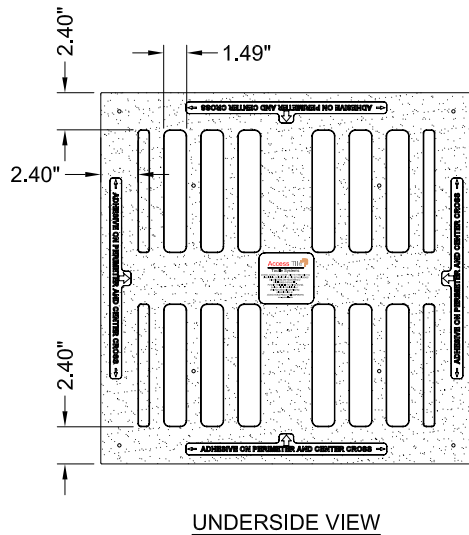
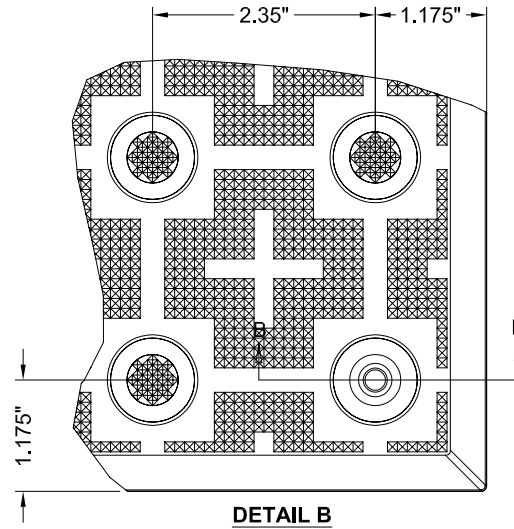
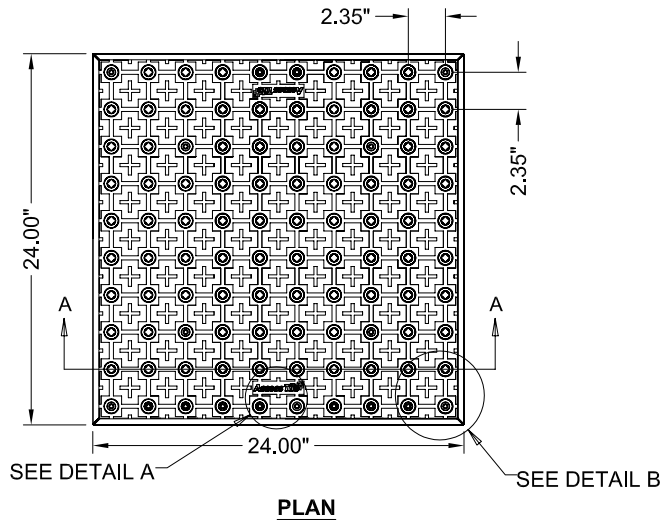

www.AccessTile.com

Access Products Inc

© Access Products Inc. ACCESS, ACCESS TILE, ACCESS AND THE THREE AND TWO DIMENSIONAL DESIGNS ON THE TILE BETWEEN DOMES AND ON DOMES ARE TRADEMARKS OF ENGINEERED SYSTEMS INC. PATENTS PENDING IN THE UNITED STATES, CANADA AND INTERNATIONALLY MANUFACTURED AND DISTRIBUTED UNDER LICENSE BY ACCESS WORLD PRODUCTS INCORPORATED www.accesstile.com
 © KENNETH E. SZEKELY

MATERIAL LIST

ITEM	DESCRIPTION	PART NO.	QTY
1	ACCESS TILE	ACC-S-2X2	1
2	Tek™ ANCHOR	ACC-S-ANCH	8
3	TACTILE BOND AND SEAL	TBS-010	1 ea

NOTE: FASTENERS AND 1 TUBE OF TACTILE BOND AND SEAL ARE INCLUDED WITH TILE

REFERENCE DRAWINGS

DWG. NO.	DESCRIPTION

No.	DATE	REVISION	APPR.

SCALE 1"=1'-0" U.N.O. FULL SIZE ONLY

DESIGNED	KES	DATE	10/09/2008
DRAWN	RWO	DATE	10/15/2008
CHECKED	KES		

PROJECT MANAGER	
TRADE	DETECTABLE WARNING SURFACE
PART NO.	ACC-S-2X2

MATERIAL POLYMER COMPOSITE
 SUBJECT **ACCESS TILE®**
 TRUNCATED DOME, DETECTABLE WARNING TACTILE SURFACE

PROJECT **ACCESS TILE®**
 TRUNCATED DOME, DETECTABLE WARNING TACTILE SURFACE
 2X2 SURFACE APPLIED
 INLINE DOME TILE DRAWING.

DRAWING NO.	ACC-S-2X2	REV. NO.	∅
-------------	-----------	----------	---

2'X3'

**SURFACE APPLIED
2.35" DOME SPACING**



Tactile Systems

www.AccessTile.com 888-679-4022

www.AccessTile.com

Access Products Inc

© Access Products Inc.
ACCESS, ACCESS TILE, ACCESS AND THE THREE AND TWO
DIMENSIONAL DESIGNS ON THE TILE BETWEEN DOMES
AND ON DOMES ARE TRADEMARKS OF
ENGINEERED SYSTEMS INC.
PATENTS PENDING IN THE UNITED STATES,
CANADA AND INTERNATIONALLY
MANUFACTURED AND DISTRIBUTED
UNDER LICENSE BY
ACCESS WORLD PRODUCTS INCORPORATED
www.accesstile.com
© KENNETH E.
SZEKELY

MATERIAL LIST

ITEM	DESCRIPTION	PART NO.	QTY
1	ACCESS TILE	ACC-S-2X3	1
2	Tek™ ANCHOR	ACC-S-ANCH	8
3	TACTILE BOND AND SEAL	TBS-010	1 ea

NOTE: FASTENERS AND 1 TUBE OF TACTILE BOND AND SEAL ARE INCLUDED WITH TILE

REFERENCE DRAWINGS

DWG. NO.	DESCRIPTION

No.	DATE	REVISION	APPR.

SCALE
1"=1'-0" U.N.O.
FULL SIZE ONLY

DESIGNED KES	DATE 10/09/2008
DRAWN RWO	10/15/2008
CHECKED KES	

PROJECT MANAGER	
-----------------	--

TRADE DETECTABLE WARNING SURFACE	PART NO. ACC-S-2X3
-------------------------------------	-----------------------

MATERIAL POLYMER COMPOSITE

SUBJECT
ACCESS TILE®
TRUNCATED DOME, DETECTABLE
WARNING TACTILE SURFACE

PROJECT
ACCESS TILE®
TRUNCATED DOME, DETECTABLE
WARNING TACTILE SURFACE
2X3 SURFACE APPLIED
INLINE DOME TILE DRAWING.

DRAWING NO. ACC-S-2X3	REV. NO. ∅
--------------------------	---------------

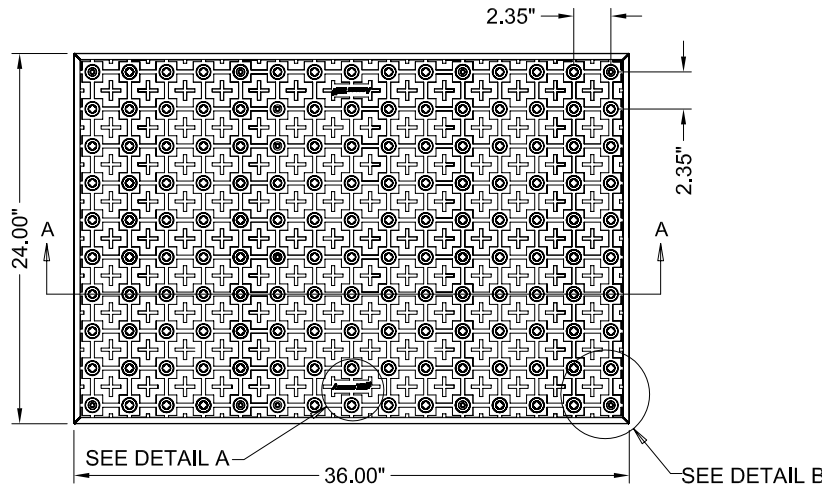

PLAN

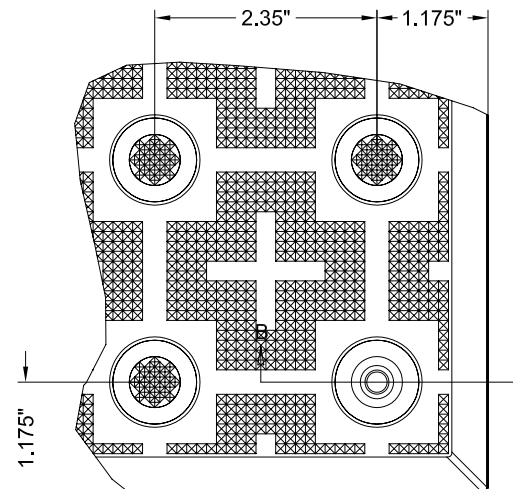

DETAIL B

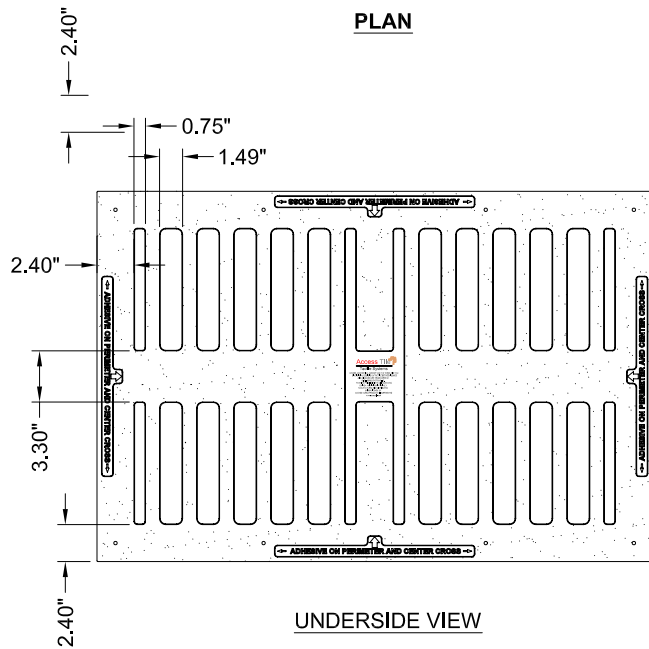

UNDERSIDE VIEW

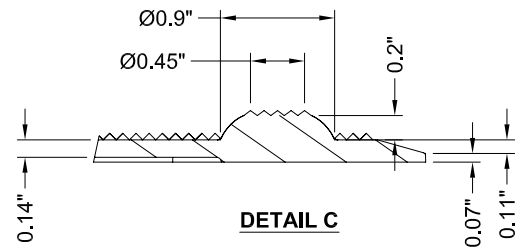

DETAIL C

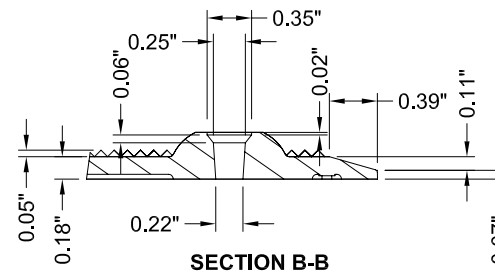

SECTION B-B

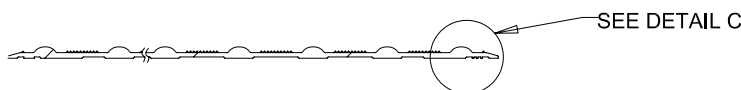

SECTION A-A



DETAIL A

2'X4'

**SURFACE APPLIED
2.35" DOME SPACING**



Tactile Systems

www.AccessTile.com 888-679-4022

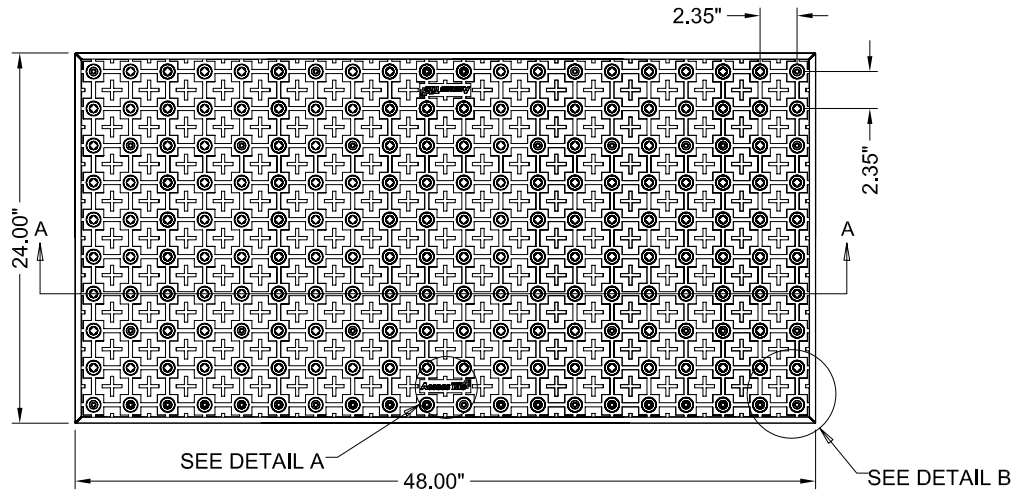

PLAN

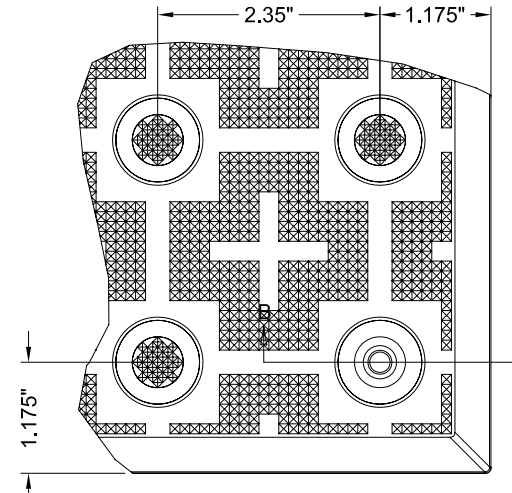

DETAIL B

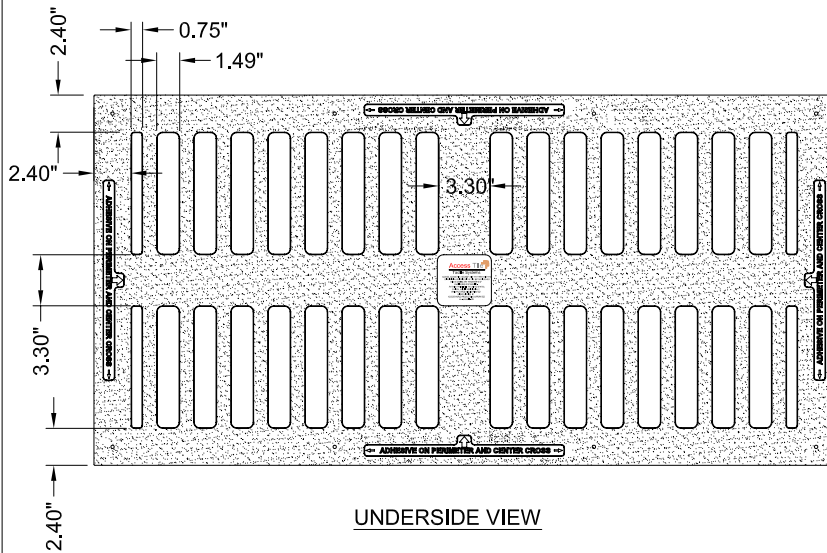

UNDERSIDE VIEW

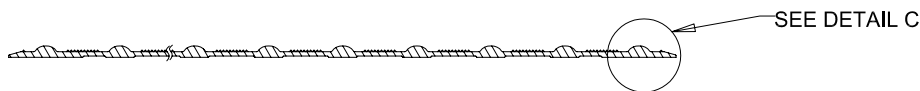

SECTION A-A

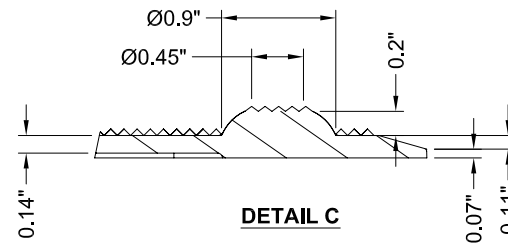

DETAIL C

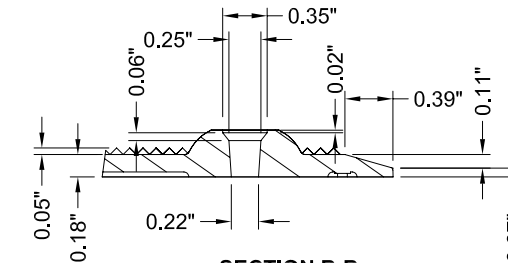

SECTION B-B



DETAIL A

www.AccessTile.com

Access Products Inc

© Access Products Inc. ACCESS TILE, ACCESS AND THE THREE AND TWO DIMENSIONAL DESIGNS ON THE TILE BETWEEN DOMES AND ON DOMES ARE TRADEMARKS OF ENGINEERED SYSTEMS INC. PATENTS PENDING IN THE UNITED STATES, CANADA AND INTERNATIONALLY. MANUFACTURED AND DISTRIBUTED UNDER LICENSE BY ACCESS WORLD PRODUCTS INCORPORATED www.accesstile.com
 ① KENNETH E. SZEKELY

MATERIAL LIST

ITEM	DESCRIPTION	PART NO.	QTY
1	ACCESS TILE	ACC-S-2X4	1
2	Tek™ ANCHOR	ACC-S-ANCH	8
3	TACTILE BOND AND SEAL	TBS-010	1 ea

NOTE: FASTENERS AND 1 TUBE OF TACTILE BOND AND SEAL ARE INCLUDED WITH TILE

REFERENCE DRAWINGS

DWG. NO.	DESCRIPTION

No.	DATE	REVISION	APPR.

SCALE 1"=1'-0" U.N.O. FULL SIZE ONLY

DESIGNED	KES	DATE	10/09/2008
DRAWN	RWO		10/15/2008
CHECKED	KES		

PROJECT MANAGER

TRADE DETECTABLE WARNING SURFACE PART NO. ACC-S-2X4

MATERIAL POLYMER COMPOSITE

SUBJECT **ACCESS TILE®**
TRUNCATED DOME, DETECTABLE WARNING TACTILE SURFACE

PROJECT **ACCESS TILE®**
TRUNCATED DOME, DETECTABLE WARNING TACTILE SURFACE
2X4 SURFACE APPLIED
INLINE DOME TILE DRAWING.

DRAWING NO.	ACC-S-2X4	REV. NO.	Ø
-------------	-----------	----------	---

2'X5'

**SURFACE APPLIED
2.35" DOME SPACING**



Tactile Systems

www.AccessTile.com 888-679-4022

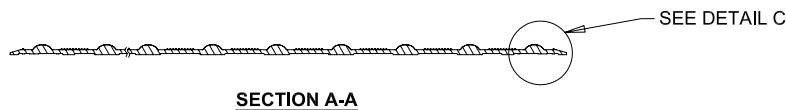
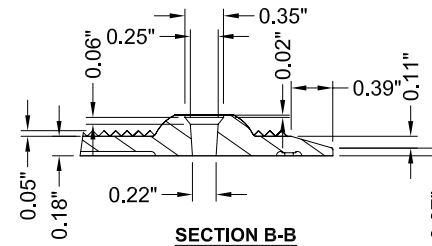
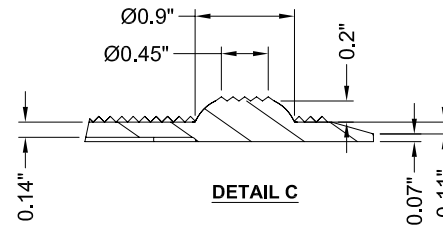
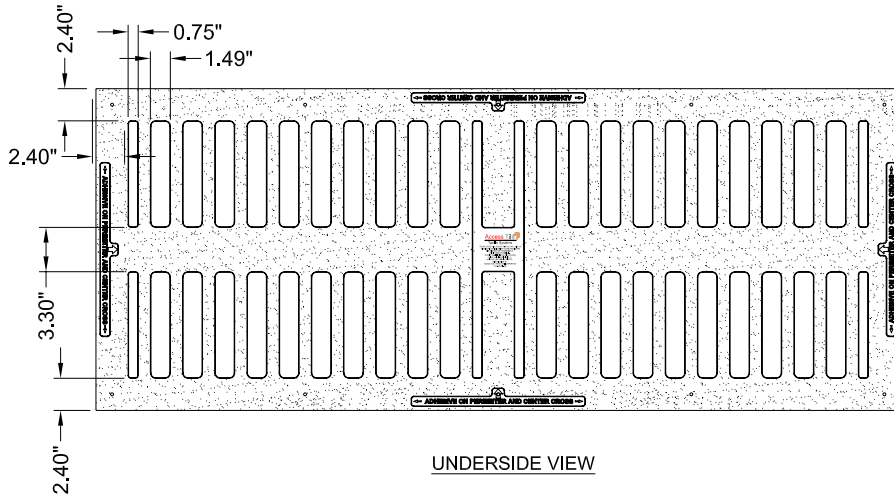
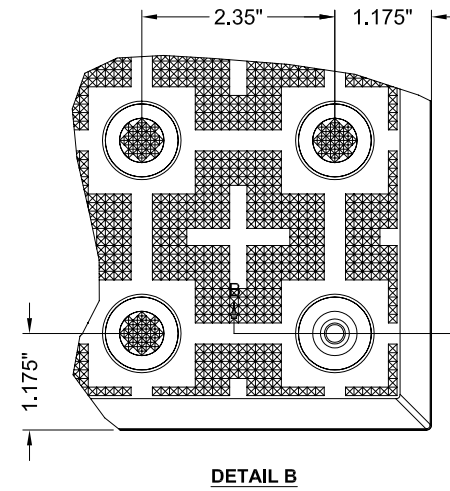
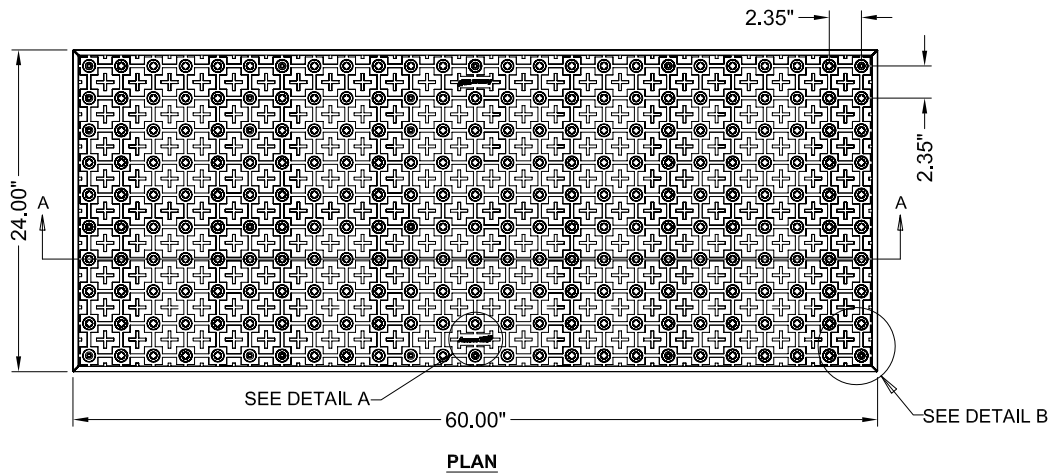

www.AccessTile.com

Access Products Inc

© Access Products Inc. ACCESS, ACCESS TILE, ACCESS AND THE THREE AND TWO DIMENSIONAL DESIGNS ON THE TILE BETWEEN DOMES AND ON DOMES ARE TRADEMARKS OF ENGINEERED SYSTEMS INC. PATENTS PENDING IN THE UNITED STATES, CANADA AND INTERNATIONALLY MANUFACTURED AND DISTRIBUTED UNDER LICENSE BY ACCESS WORLD PRODUCTS INCORPORATED www.accesstile.com
 © KENNETH E. SZEKELY

MATERIAL LIST

ITEM	DESCRIPTION	PART NO.	QTY
1	ACCESS TILE	ACC-S-2X5	1
2	Tek™ ANCHOR	ACC-S-ANCH	10
3	TACTILE BOND AND SEAL	TBS-010	1 ea

NOTE: FASTENERS AND 1 TUBE OF TACTILE BOND AND SEAL ARE INCLUDED WITH TILE

REFERENCE DRAWINGS

DWG. NO.	DESCRIPTION

No.	DATE	REVISION	APPR.

SCALE 1"=1'-0" U.N.O. FULL SIZE ONLY

DESIGNED BY KES	DATE 10/09/2008
DRAWN BY RWO	DATE 10/15/2008
CHECKED BY KES	

PROJECT MANAGER	
-----------------	--

TRADE DETECTABLE WARNING SURFACE	PART NO. ACC-S-2X5
-------------------------------------	-----------------------

MATERIAL POLYMER COMPOSITE

SUBJECT
ACCESS TILE®
 TRUNCATED DOME, DETECTABLE WARNING TACTILE SURFACE

PROJECT
ACCESS TILE®
 TRUNCATED DOME, DETECTABLE WARNING TACTILE SURFACE
 2X5 SURFACE APPLIED
 INLINE DOME TILE DRAWING.

DRAWING NO. ACC-S-2X5	REV. NO. Ø
--------------------------	---------------

3'X4'

**SURFACE APPLIED
2.35" DOME SPACING**



Tactile Systems

www.AccessTile.com 888-679-4022

www.AccessTile.com

Access Products Inc

© Access Products Inc. ACCESS, ACCESS TILE, ACCESS AND THE THREE AND TWO DIMENSIONAL DESIGNS ON THE TILE BETWEEN DOMES AND ON DOMES ARE TRADEMARKS OF ENGINEERED SYSTEMS INC. PATENTS PENDING IN THE UNITED STATES, CANADA AND INTERNATIONALLY MANUFACTURED AND DISTRIBUTED UNDER LICENSE BY ACCESS WORLD PRODUCTS INCORPORATED www.accesstile.com
 © KENNETH E. SZEKELY

MATERIAL LIST

ITEM	DESCRIPTION	PART NO.	QTY
1	ACCESS TILE	ACC-S-3X4	1
2	Tek™ ANCHOR	ACC-S-ANCH	12
3	TACTILE BOND AND SEAL	TBS-010	1 ea

NOTE: FASTENERS AND 1 TUBE OF TACTILE BOND AND SEAL ARE INCLUDED WITH TILE

REFERENCE DRAWINGS

DWG. NO.	DESCRIPTION

No.	DATE	REVISION	APPR.

SCALE
 1"=1'-0" U.N.O. FULL SIZE ONLY

DESIGNED BY KES	DATE 10/09/2008
DRAWN BY RWO	DATE 10/15/2008
CHECKED BY KES	

PROJECT MANAGER

TRADE
 DETECTABLE WARNING SURFACE

MATERIAL
 POLYMER COMPOSITE

SUBJECT
ACCESS TILE®
 TRUNCATED DOME, DETECTABLE
 WARNING TACTILE SURFACE

PROJECT
ACCESS TILE®
 TRUNCATED DOME, DETECTABLE
 WARNING TACTILE SURFACE
 3X4 SURFACE APPLIED
 INLINE DOME TILE DRAWING.

DRAWING NO. ACC-S-3X4	REV. NO. ∅
--------------------------	---------------

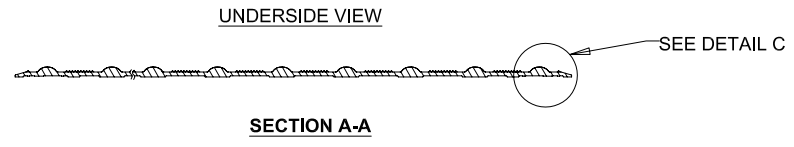
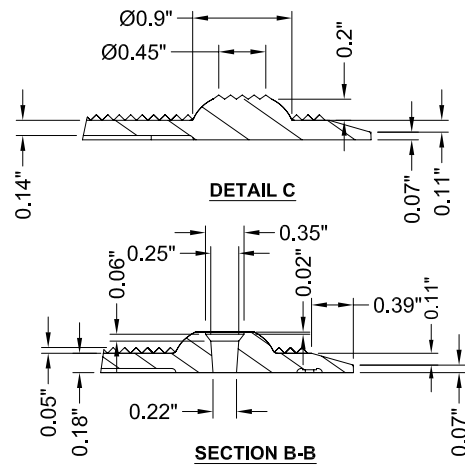
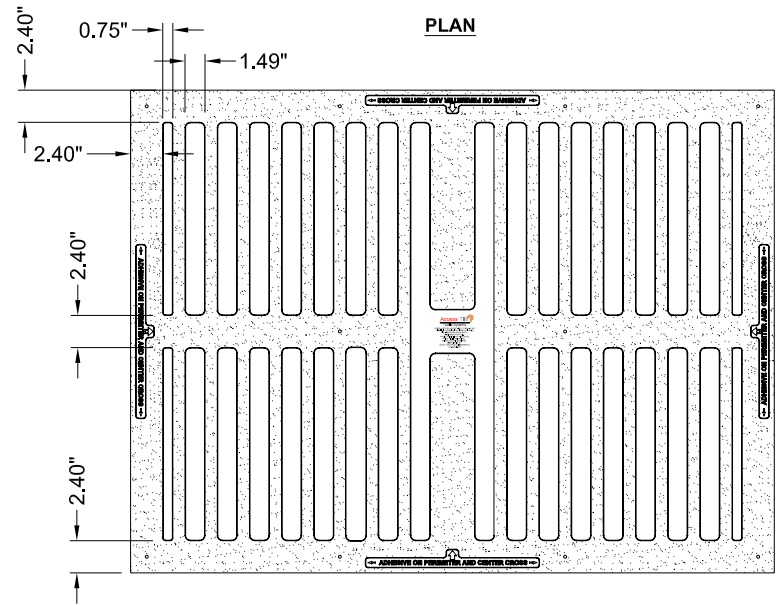
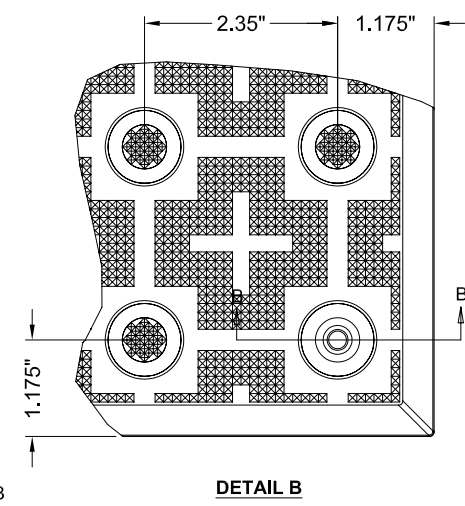
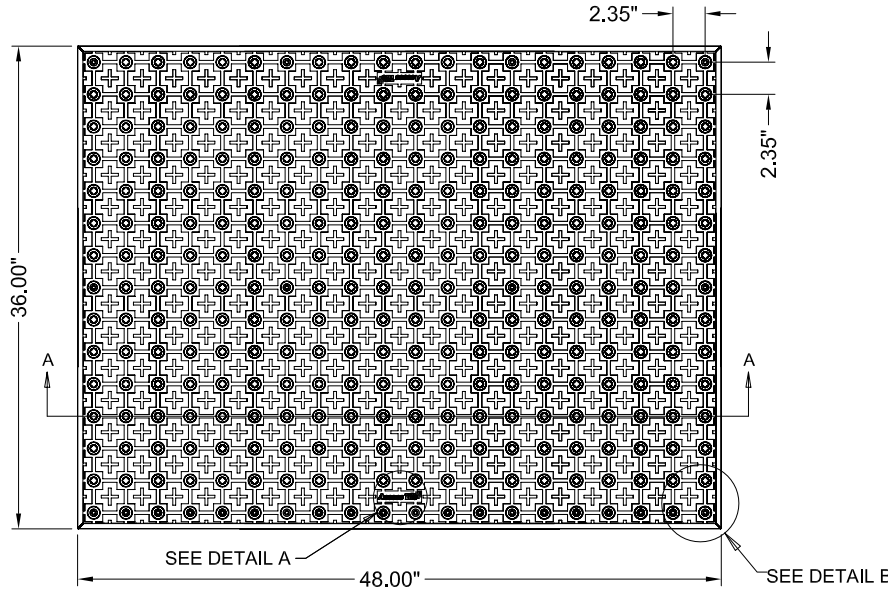

DETAIL A

3'X5'

**SURFACE APPLIED
2.35" DOME SPACING**



Tactile Systems

www.AccessTile.com 888-679-4022

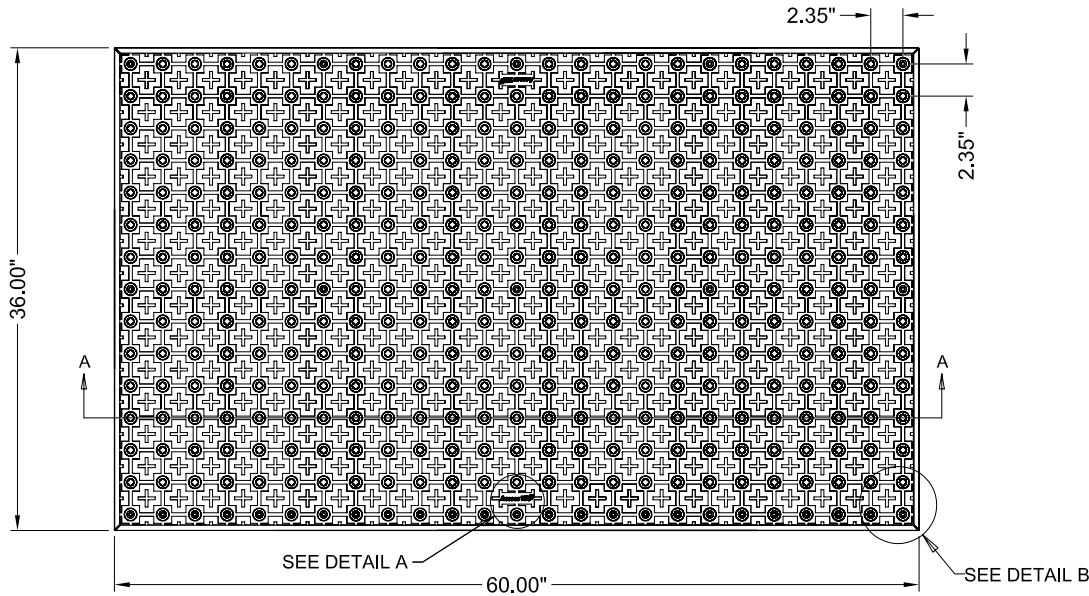

PLAN

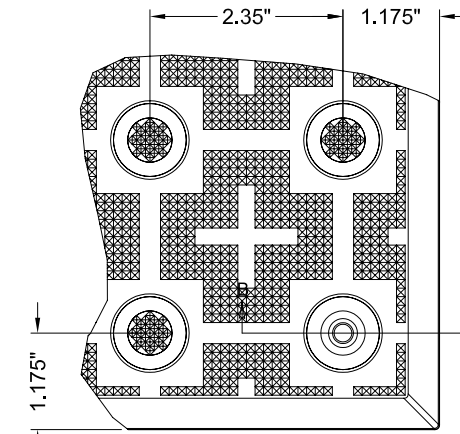

DETAIL B

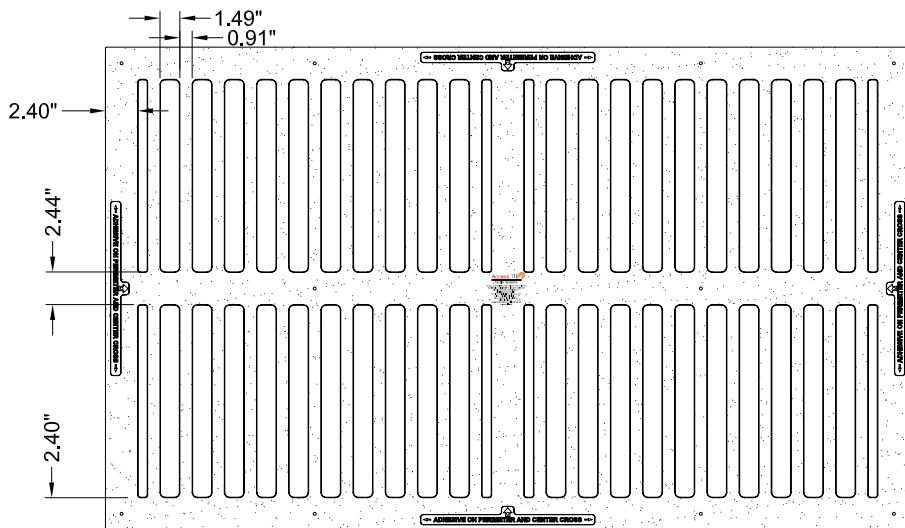

UNDERSIDE VIEW

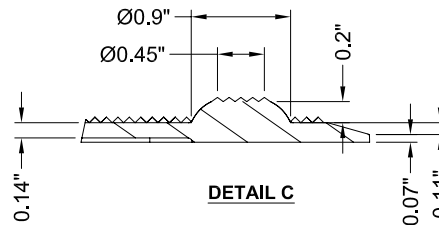

DETAIL C

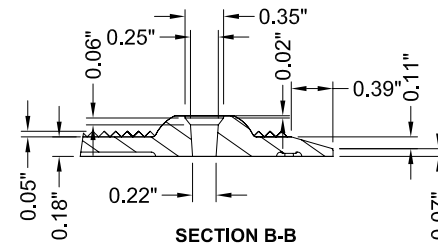

SECTION B-B



SECTION A-A

www.AccessTile.com

Access Products Inc

© Access Products Inc. ACCESS, ACCESS TILE, ACCESS AND THE THREE AND TWO DIMENSIONAL DESIGNS ON THE TILE BETWEEN DOMES AND ON DOMES ARE TRADEMARKS OF ENGINEERED SYSTEMS INC. PATENTS PENDING IN THE UNITED STATES, CANADA AND INTERNATIONALLY MANUFACTURED AND DISTRIBUTED UNDER LICENSE BY ACCESS WORLD PRODUCTS INCORPORATED www.accesstile.com
 © KENNETH E. SZEKELY

MATERIAL LIST

ITEM	DESCRIPTION	PART NO.	QTY
1	ACCESS TILE	ACC-S-3X5	1
2	Tek™ ANCHOR	ACC-S-ANCH	15
3	TACTILE BOND AND SEAL	TBS-010	1 ea

NOTE: FASTENERS AND 1 TUBE OF TACTILE BOND AND SEAL ARE INCLUDED WITH TILE

REFERENCE DRAWINGS

DWG. NO.	DESCRIPTION

No.	DATE	REVISION	APPR.

SCALE 1"=1'-0" U.N.O. FULL SIZE ONLY

DESIGNED BY	KES	DATE	10/09/2008
DRAWN BY	RWO	DATE	10/15/2008
CHECKED BY	KES		

PROJECT MANAGER

TRADE DETECTABLE WARNING SURFACE PART NO. ACC-S-3X5

MATERIAL POLYMER COMPOSITE

SUBJECT **ACCESS TILE®**
TRUNCATED DOME, DETECTABLE WARNING TACTILE SURFACE

PROJECT **ACCESS TILE®**
TRUNCATED DOME, DETECTABLE WARNING TACTILE SURFACE
3X5 SURFACE APPLIED
INLINE DOME TILE DRAWING.

DRAWING NO.	ACC-S-3X5	REV. NO.	∅
-------------	-----------	----------	---



CURVE

SURFACE APPLIED 2.35" DOME SPACING



Tactile Systems

888-679-4022

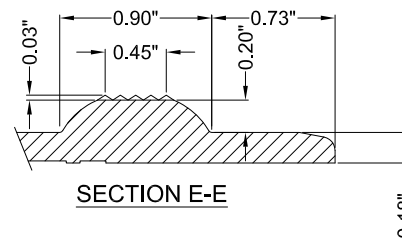
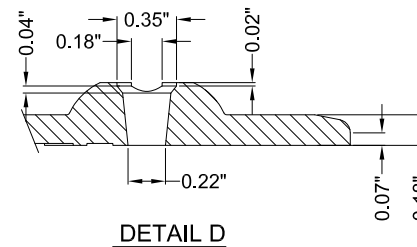
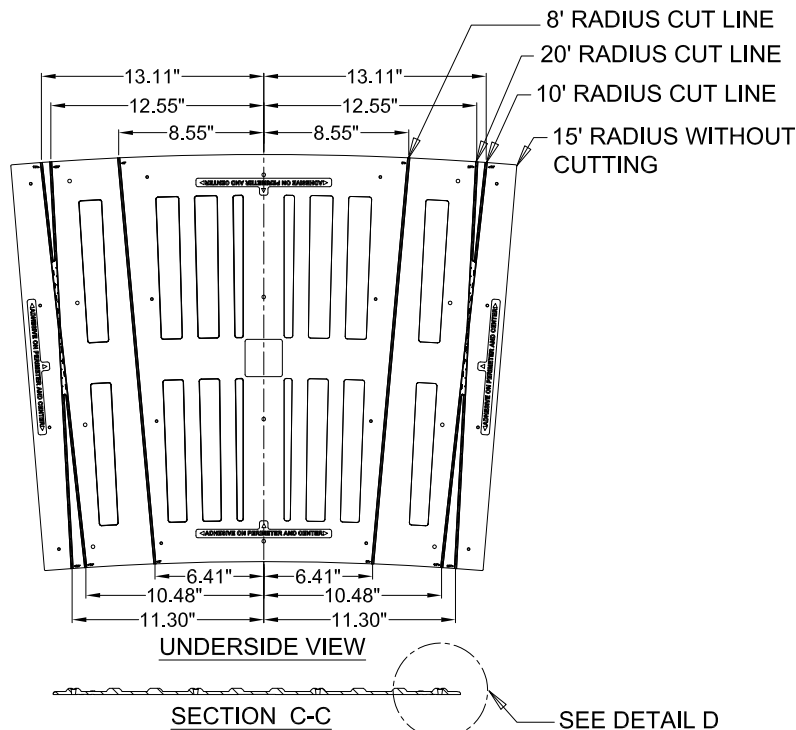
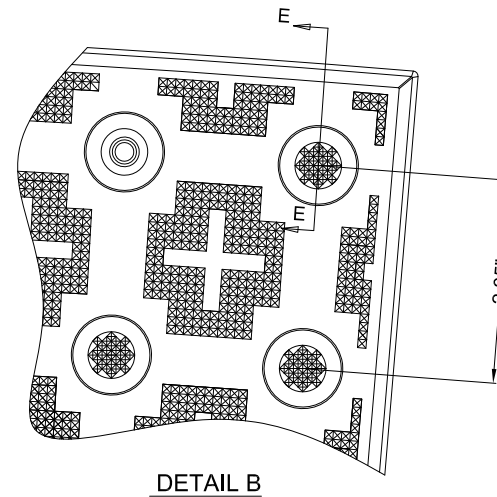
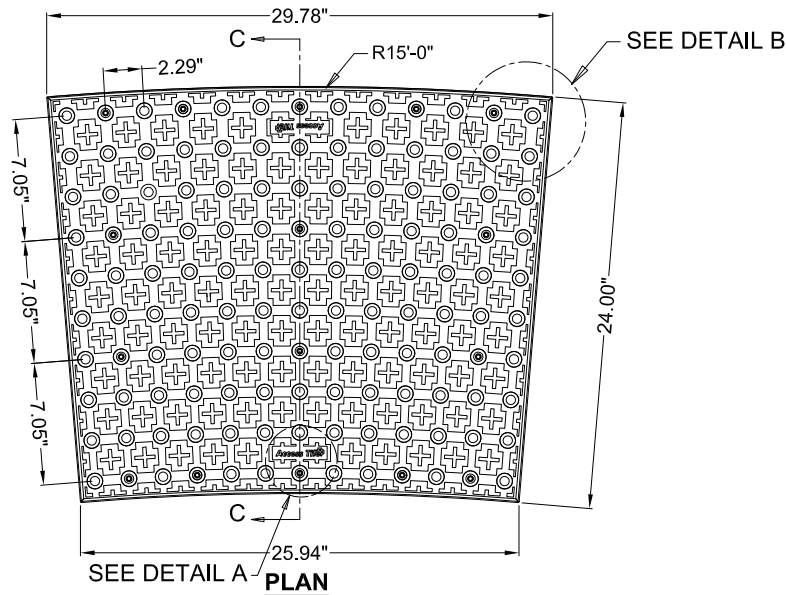

AccessTile.com

Access Products Inc.

ACCESS, ACCESS TILE, ACCESS, AND THE THREE AND TWO DIMENSIONAL DESIGNS ON THE TILE BETWEEN DOMES AND ON DOMES ARE TRADEMARKS OF ENGINEERED SYSTEMS INC.

PATENTS PENDING IN THE UNITED STATES, CANADA AND INTERNATIONALLY.

MANUFACTURED AND DISTRIBUTED UNDER LICENSE BY ACCESS WORLD PRODUCTS INCORPORATED.

MATERIAL LIST

ITEM	DESCRIPTION	PART NO.	QTY
1	ACCESS TILE	ACC-S-2X2CRV	1
2	Tek™ ANCHOR	ACC-S-ANCH	16
3	TACTILE BOND AND SEAL	TBS-010	1 ea

NOTE: FASTENERS AND 1 TUBE OF TACTILE BOND AND SEAL ARE INCLUDED WITH TILE

REFERENCE DRAWINGS

DWG. NO.	DESCRIPTION

No.	DATE	REVISION	APPR.

SCALE 1"=1'-0" U.N.O. FULL SIZE ONLY

DESIGNED	KES	DATE	12/20/2013
DRAWN	VS	DATE	06/26/2014
CHECKED	DD		

PROJECT MANAGER	
TRADE	PART NO.
DETECTABLE WARNING SURFACE	ACC-S-2X2CRV

MATERIAL POLYMER COMPOSITE

SUBJECT **ACCESS TILE®**
TRUNCATED DOME, DETECTABLE WARNING TACTILE SURFACE

PROJECT **ACCESS TILE®**
TRUNCATED DOME, DETECTABLE WARNING TACTILE SURFACE
2X2 CURVED SURFACE APPLIED INLINE DOME TILE DRAWING.

DRAWING NO.	ACC-S-2X2CRV	REV. NO.	Ø
-------------	--------------	----------	---



Tactile Systems

CLEANING AND MAINTENANCE MANUAL

The Access Tile Detectable Warning Tile is unique in its visual and tactile properties and requires a slight variation in cleaning procedures. Due to the undulation and texture of the tile surface, it is necessary to reach the grime that rests on the low parts of the tile. Standard wet mopping will not be completely effective in cleaning these textured surfaces. A major benefit of the polymer composite tile is that the composition is virtually non-porous, and prevents liquids, dust and grime seeping into the body of the tile. The unique, non-porous nature of the tile therefore lends itself to regular and frequent cleaning in order to maintain and enhance the visual contrast that the bright yellow tile provides. Visual contrast is an essential safety feature of the tactile tiles, and this contrast must be rigorously maintained with regular cleaning in order to provide the contrast that the visually impaired rely on for their safety. The use of general purpose commercial floor cleaners or machine bristle scrubbing will not harm Access Tile. However, as these cleaning practices may weaken or dissolve the adjacent floor finish, careful attention must be paid to the selection and application of the cleaning solution. It is advisable to check with the manufacturer of the cleaning solution in order to be certain that the product intended to be used will not harm the Access Tile, grout, or the adjacent floor finish in any way.

Regular Maintenance

Many neutral general purpose cleaners are effective for the regular maintenance and cleaning of Access Tile. It is important that the cleaner to be used has a non-oil, non-animal fat, non-soap base. Cleaners with these bases may cause problems due to oil-residues which tend to trap dirt in the cleaning process.

Please remember to treat any cleaning product you wish to use on a small, out of the way test area of the tactile surface and adjacent floor area before applying it to the entire Access Tile surface. This will ensure that it performs as desired, not only on the Access Tile surface but also on the adjacent floor finish, thus avoiding unexpected problems.

Avoid Surface Coatings

Access Tile does not require the use of sealants or waxes. Adding surface coatings increases the number of unnecessary steps in maintenance procedures without improving either the appearance of the tile, or the resistance to dirt build-up. In fact, using a surface coating turns a low maintenance composite finish into a high maintenance tile.

In addition, surface coatings will actually diminish the unique performance characteristics that make Access Tile exceptional among tactile tiles. Such surface coatings create a thin barrier that may modify the skid resistance and visibility properties, thereby reducing an important safety feature of the flooring.



Tactile Systems

Certificate of Compliance*

July 1, 2021

*issued on a per project basis

Contract Number / Date:

Project Description:

Installer:

Owner:

Product Installed:

Access Products Inc. certifies that the Access Tile and specified installation materials are in compliance with the following:

Americans with Disabilities Act (ADA) (Title III Regulations, 28 CFR Part 36 ADA STANDARDS FOR ACCESSIBLE DESIGN, Appendix A, Section 4.29.2 DETECTABLE WARNINGS ON WALKING SURFACES).

California Code of Regulations (CCR): Provide only approved DSAAC detectable warning products as provided in the California Code of Regulations (CCR) Title 24, Chapter 2, Section 202 definition of "Detectable Warning". Section 11B-247 and 11B-705 "Detectable Warnings and Detectable Directional Texture"

ISO 23599: 2012(E): Assistive Products for Blind and Vision Impaired Persons – Tactile Walking Surface Indicators.

CSA B651-12: Accessible Design for the Built Environment Standard
Integrated Accessibility Standards Regulation 191/11 – Sections 80.25 to 80.29

Please visit our web site www.accesstile.com or call us directly for additional information regarding our products and services.

Sincerely,

John Heffner
Vice President

ACCESS PRODUCTS INC.

241 Main Street • Suite 100 • Buffalo, NY 14203 T: (888) 679.4022 F: (877) 679.4022
www.accesstile.com | www.accessproducts.com



Tactile Systems

MATERIAL WARRANTY*

Contract No./Date:
Project Description:
No. and Type of Tiles:
Installer:
Owner:

***issued on a per project basis**

Access Products Inc. warrants to the Owner that the Access Tile Detectable Warning Tile manufactured by Access Products Inc. and the adhesive is free from Manufacturer defects for a period of Five (5) years from the date of sale.

EXCLUSIVE REMEDIES. Access Products Inc., at its cost, will repair or replace defective material promptly reported to Access Products Inc. during the warranty period. This warranty includes labor costs and cost of removal of product. Repair or replacement will be done on site.

WARRANTY LIMITATIONS. Access Tile Inc. warranty of Access Tile products does not apply to conditions resulting from improper installation, improper use, external causes, intentional misuse or abuse, neglected or improper annual maintenance, vandalism, modifications to the Access Tile products or installation procedures with the exception of the Owner's right to immediately eliminate an unsafe condition.

DISCLAIMER OF WARRANTIES The above warranties are the Owner's exclusive warranties. No other warranty, express or implied, shall apply. Access Products Inc. specifically makes no warranty of merchantability and/or fitness for a particular purpose.

IN NO EVENT WILL ACCESS PRODUCTS INC. BE LIABLE FOR ANY DAMAGES, LOST PROFIT, DIRECT, CONSEQUENTIAL OR ECONOMIC DAMAGES.

MATERIAL SUPPLIER:

Access Products Inc.

Authorized Signature

John Heffner
Vice President
July 1, 2021

ACCESS PRODUCTS INC.

241 Main Street • Suite 100 • Buffalo, NY 14203 T: (888) 679.4022 F: (877) 679.4022
www.accesstile.com | www.accessproducts.com